

C	5	24	7	11	02	10	02	31	14	23	1	24	12	3	11	20	18	20	11	2	4	18	23	10	38	29	42	41	40	45	44	44	47	48	49	54	56	58	53	55	71	72	73	74	75	76	77	78	79	80	81	82	83	84	85	86	87	88	89	90	91	92	93	94	95	96	97	98	99	100																					
R	30	31	32	33	34	35	36	37	38	39	40	41	42	43	44	45	46	47	48	49	50	51	52	53	54	55	56	57	58	59	60	61	62	63	64	65	66	67	68	69	70	71	72	73	74	75	76	77	78	79	80	81	82	83	84	85	86	87	88	89	90	91	92	93	94	95	96	97	98	99	100																				
S	13	11	12	13	14	15	16	17	18	19	20	21	22	23	24	25	26	27	28	29	30	31	32	33	34	35	36	37	38	39	40	41	42	43	44	45	46	47	48	49	50	51	52	53	54	55	56	57	58	59	60	61	62	63	64	65	66	67	68	69	70	71	72	73	74	75	76	77	78	79	80	81	82	83	84	85	86	87	88	89	90	91	92	93	94	95	96	97	98	99	100

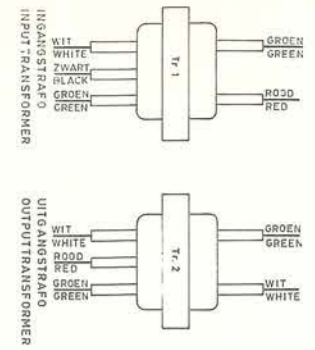

DE SPANNINGEN ZIJN GEMETEN T.O.V. L.
VOLTAGES ARE MEASURED AGAINST L.

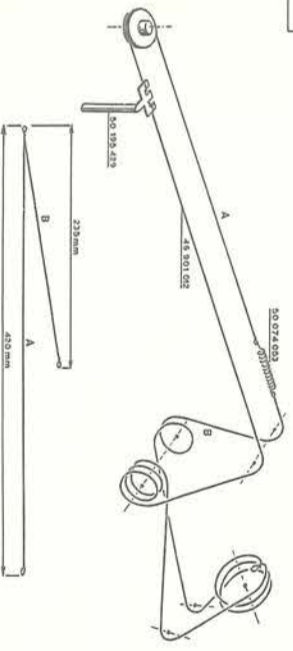
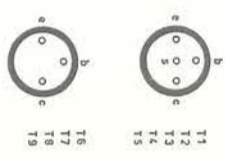

ERRES RP 1466

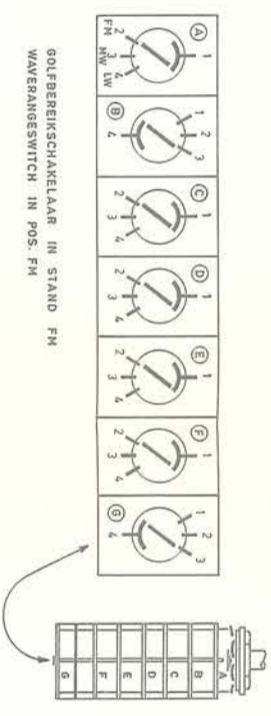
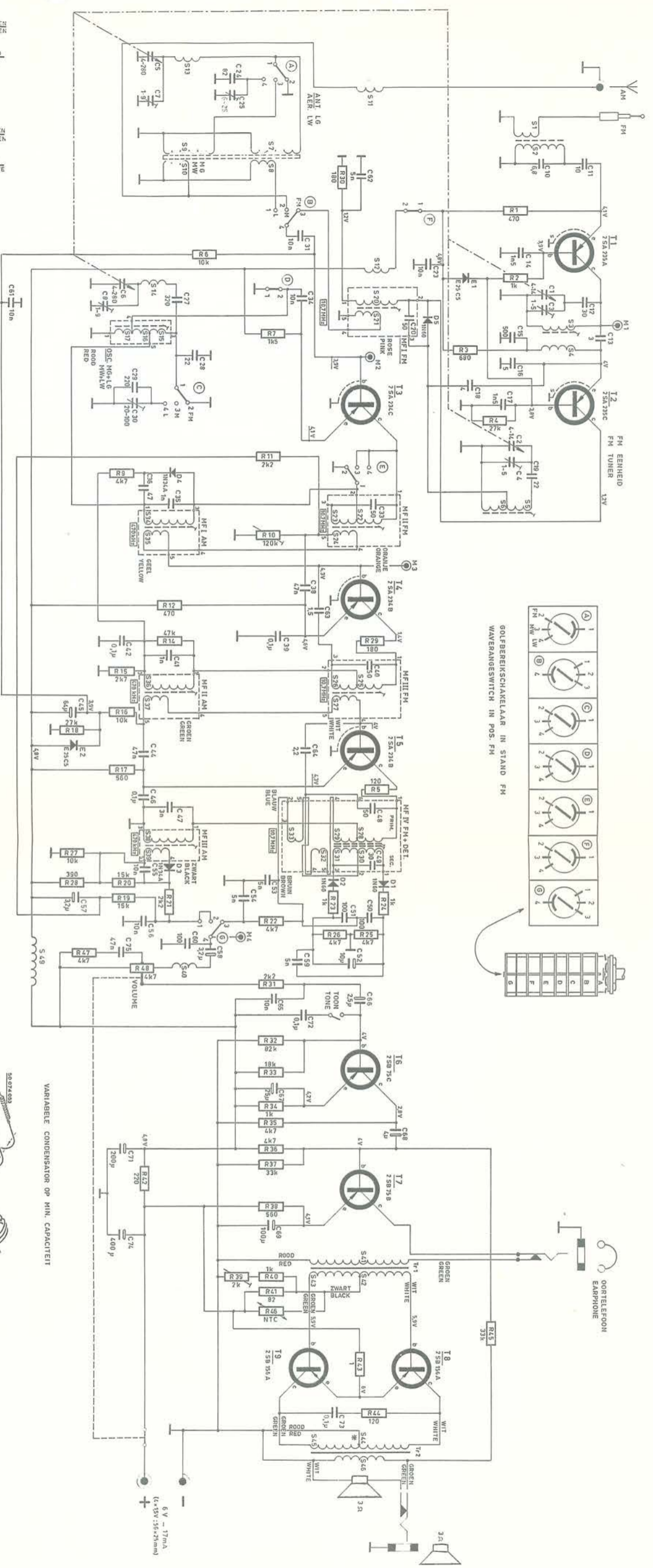

6V - 17mA
(4.5V - 15.75mA)

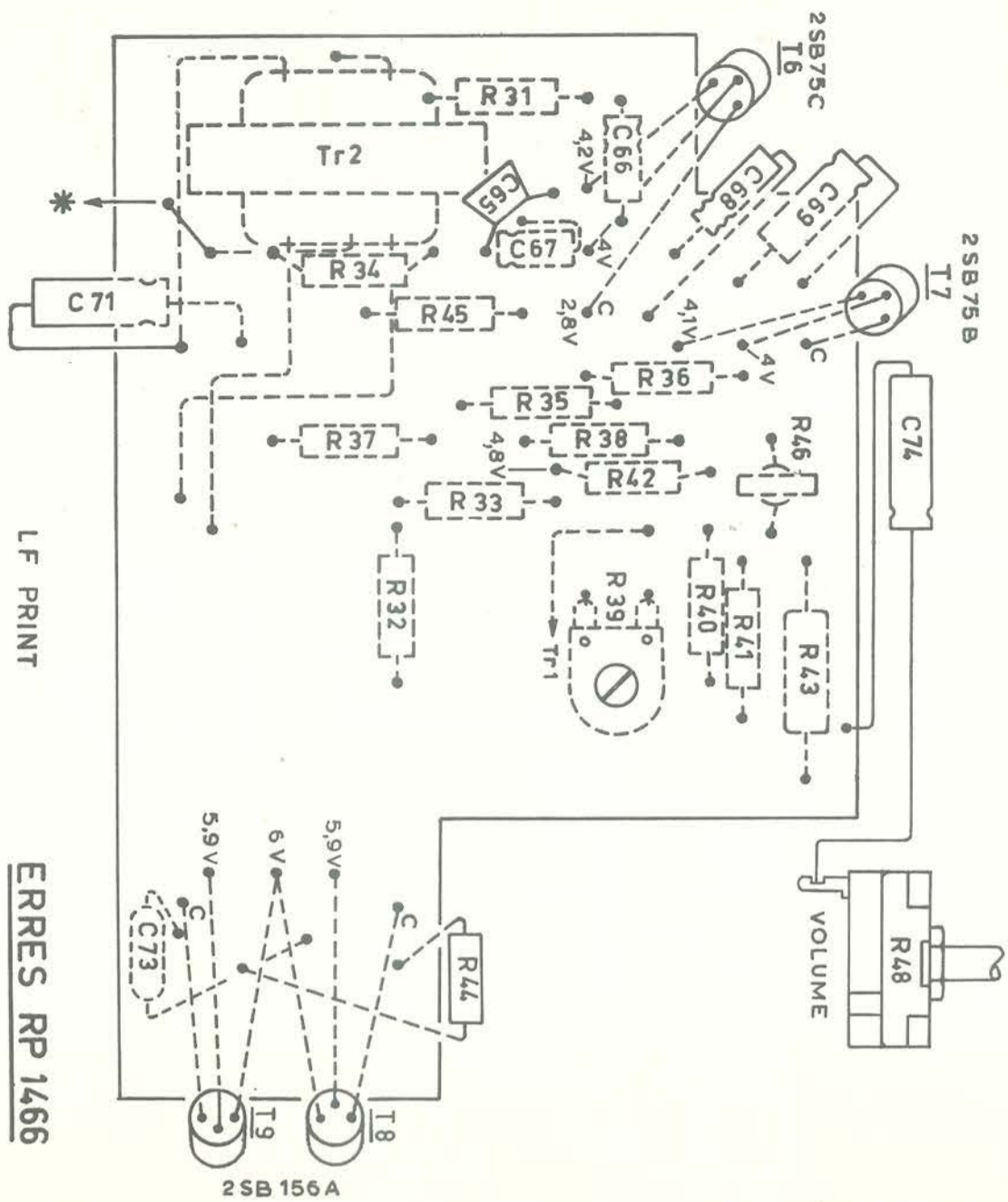

C	66	68	69	74	73								
R	31	34	45	36	35	37	42	33	40	41	43	44	48

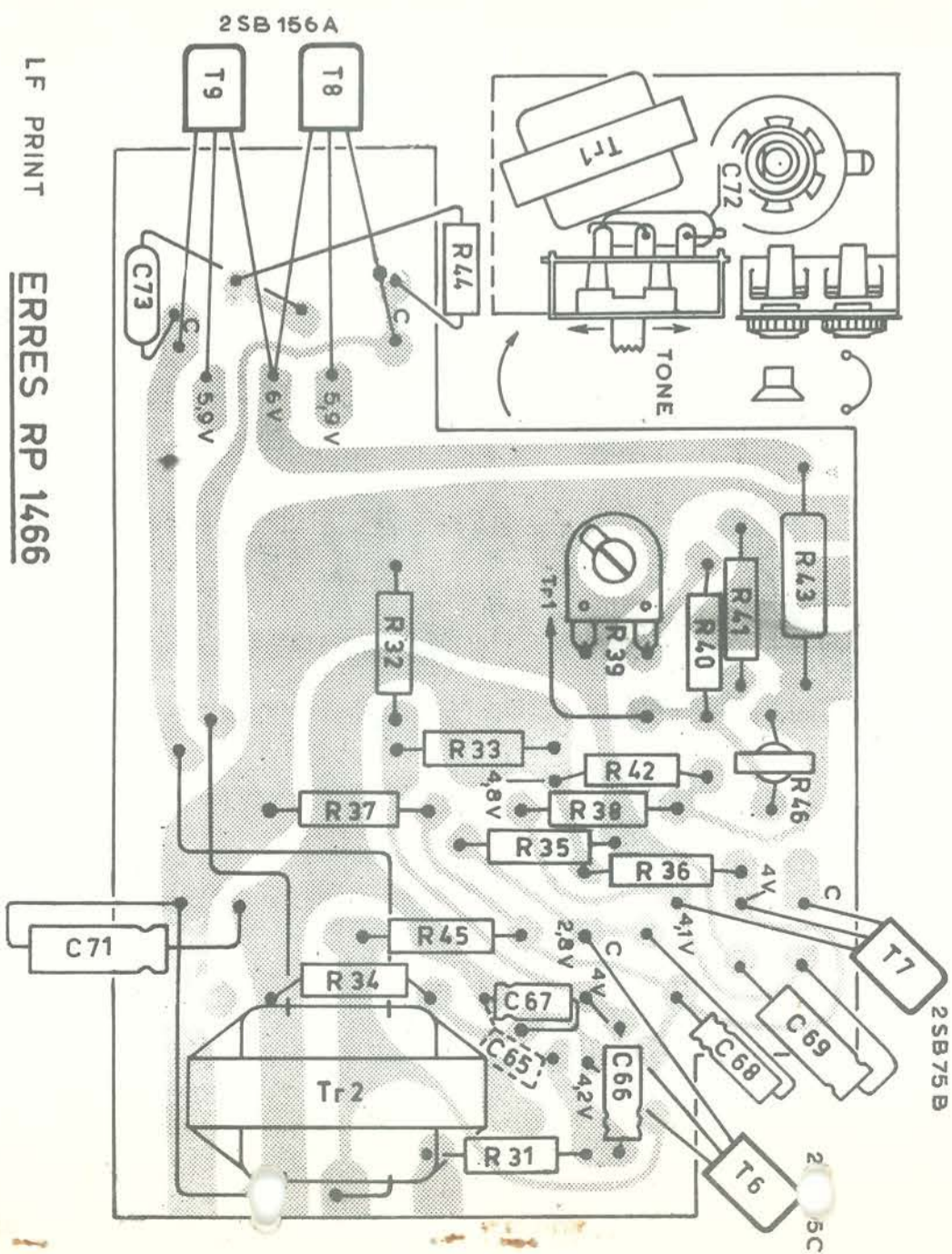

C	72	73	71	69	68	66			
R	44	43	41	40	46	38	36	45	34

HF/MF
RF/IF PRINT

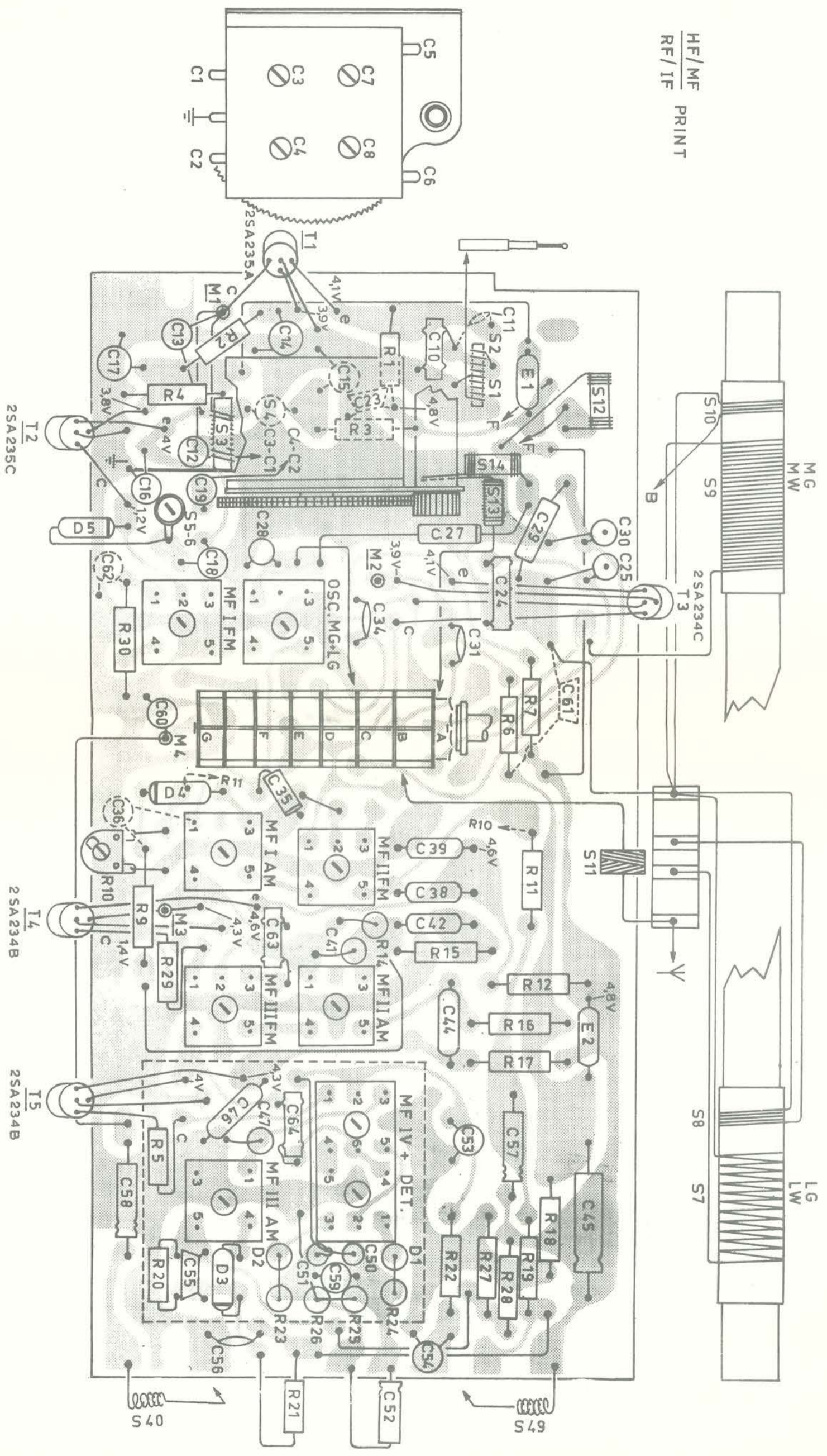

ERRES RP 1466

C	5	7	8	6	11	14	15	19	30	29	28	25	24	31	61	35	39	38	42	41	44	64	46	47	53	58	50	59	54	52
R	3	1	4	2	10	13	17	12	16	27	18	62	34	60	7	36	11	9	14	29	17	5	18	19	20	22	25	23	21	