

# SERVICE MANUAL

## KY 5541 AV

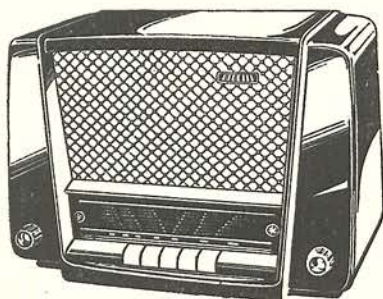

Receiver for automatic current and with the aid of a vibrator unit suitable for 6 volts and 12 volts car battery.

(Tropicalized)



### I. GENERAL DATA

- a. Waveranges:
- |         |             |                  |
|---------|-------------|------------------|
| S.W.I   | 11.5 - 24 m | 26.5 - 12.5 Mc/s |
| S.W.II  | 23.5 - 51 m | 12.7 - 5.8 Mc/s  |
| S.W.III | 51 - 175 m  | 5.9 - 1.7 Mc/s   |
| M.W.    | 185 - 580 m | 1.63 - 0.52 Mc/s |
- b. Valves:
- |     |        |
|-----|--------|
| B 1 | ECH 81 |
| B 2 | EF 41  |
| B 3 | EBC 41 |
| B 4 | EL 84  |
| B 5 | EZ 80  |
- c. Tuned circuits: H.F.: 1 + 1  
I.F.: 2 + 2
- d. Intermediate frequency: Nominal 453 Kc/s
- e. Sensitivity: Better than 10  $\mu$ V
- f. Output: 3.2 W at 10% distortion measured at 400 c/s
- g. Selectivity: The I.F. bandwidth for a 10 fold signal is 10 Kc/s
- h. Mains supply: Adjustable to mains tensions of 110 V, 125 V, 150 V, 200 V, 220 V and 250 V
- i. Controls: Volume control + switch for mains and car battery  
Pushbuttons for switch off and four waveranges  
Tone control  
Tuning knob  
Gramophone switch (on back panel)
- j. Dimensions cabinet: 416 x 277 x 213 mm
- k. Weight: Gross 9,7 kgs; net 6,6 kgs.

## II. VOLTAGES AND CURRENTS

	EL 84	EBC 41	EF 41	ECH 81	
Va	240	65	250	260	Volts
Vg <sub>2</sub>	250		92	80	Volts
Vg <sub>1</sub>			0		Volts
Va triode				100	Volts
Vk	6.8	0	0	0	Volts
Ia	39	0.63	5	2	mA
Ig <sub>2</sub>	5		1.5	4	mA
Ig <sub>1</sub> triode				220	μA
Ia triode				4	mA
Ik	44	0.63	6.5	10	mA

$V_{C16} = 280$  Volts,  $V_{C17} = 270$  Volts,  $V_{C22} = 250$  Volts

## III. TRIMMING INSTRUCTIONS

Signal generator: Modulate 30% with 400 c/s

Pointer adjustment: Turn variable condenser fully out 0°  
Set pointer on the beginning of the scale

Trimming points: Marks are indicated on the dial for:  
0° - 62.5° - 65° - 81° - 92° - 380° - 445.5° - 471° and 482°  
turning in of variable condenser

Adjustment: Volume control on maximum  
Tone control in medium position

Range	Frequency	Position of condenser	Connection	Sequence of adjusting	
I.F.	453 Kc/s	517.5° M.W.	via 22000 pF to g <sub>1</sub> of B 1	S23-S22-S21-S20 damped	
I.F. filter	453 Kc/s	517.5° M.W.	via 22000 pF to switch 9a	S 9-S10-S 9	
S.W.I	13 Mc/s 24 Mc/s	445.5° 92°	via art. aerial	osc.circuit	aer.circuit
				S13 C23	S 3 C 3
S.W.II	6.5 Mc/s 12 Mc/s	380° 62.5°	via art. aerial	S15 C24	S 5 C 4
				S17 C25	S 7 C 5
S.W.III	1.8 Mc/s 5.5 Mc/s	482° 65°	via art. aerial	S19 C26	S 8 C 6
M.W.	550 Kc/s 1500 Kc/s	471° 81°	via art. aerial		



C o n d e n s e r s

C 1	680 pF	E 110 50/680E	C24	1.5-12.5 pF	82754/12E5
2	3000 pF	E 360 05/3K	25	6-25 pF	82754/25E
3	3-30 pF	7864/01	26	6-25 pF	82754/25E
4	6-50 pF	82754/50E	27	300 pF	E 360 02/300E
5	6-50 pF	82754/50E	28	100 pF	E 360 02/100E
6	1-10 pF	AC 2001/10	29	220 pF	E 360 02/220E
7	300 pF	E 360 02/300E	30	10000 pF	E 112 50/10K
8	10-490 pF)	GK 210 55	31	10000 pF	E 112 50/10K
9	11-512 pF)		32	100 pF	E 360 02/100E
10	220 pF	E 103 10/220E	33	220 pF	E 360 02/220E
11	270 pF	E 350 05/270E	34	10000 pF	E 112 50/10K
12	12 pF	E 101 10/12E	35	2200 pF	E 201 10/2K2
13	10000 pF	E 112 50/10K	36	100 pF	E 103 10/100E
14	10 pF	E 125 10/10E	37	4700 pF	E 201 10/4K7
15	47 pF	E 103 10/47E	38	22000 pF	E 220 10/22K
16	50 $\mu$ F)	GK 18012	39	0.1 $\mu$ F	E 201 10/100K
17	50 $\mu$ F)		40	220 pF	E 103 10/220E
18	100 pF	E 103 10/100E	41	10000 pF	E 201 10/10K
19	560 pF	E 361 10/560E	42	390 pF	E 103 10/390E
20	2000 pF	E 360 05/2K	43	100 $\mu$ F	AC 5703/100
21	430 pF	E 350 02/430E	44	6800 pF	E 202 10/6K8
22	16 $\mu$ F	GK 180 40	45	47000 pF	E 200 10/47K
23	1.5-12.5 pF	82754/12E5	46	0.1 $\mu$ F	E 200 10/100K

R e s i s t o r s

R 1	1500 $\Omega$	GK 776 10/1K5	R14	0.1 $\Omega$	GK 776 10/100K
2	1 M $\Omega$	GK 776 10/1M	15	0.2+1.8 M $\Omega$	GK 809 34
3	39000 $\Omega$	GK 777 10/39K	16	220 $\Omega$	GK 776 10/220E
4	33000 $\Omega$	GK 776 10/33K	17	10 M $\Omega$	GK 776 10/10M
5	33000 $\Omega$	GK 777 10/33K	18	0.1 $\Omega$	GK 776 10/100K
6	220 $\Omega$	5496A/220E	19	0.22 M $\Omega$	GK 776 10/220K
7	560 $\Omega$	GK 777 10/560E	20	1000 $\Omega$	GK 776 10/1K
8	3.3 M $\Omega$	GK 776 10/3M3	21	0.68 M $\Omega$	GK 776 10/680K
9	0.1 M $\Omega$	GK 776 10/100K	22	150 $\Omega$	GK 777 10/150E
10	0.1 M $\Omega$	GK 776 10/100K	23	3300 $\Omega$	GK 776 10/3K3
11	0.39 M $\Omega$	GK 776 10/390K	24	3300 $\Omega$	GK 776 10/3K3
12	0.1 M $\Omega$	GK 776 10/100K	25	220 $\Omega$	GK 776 10/220E
13	0.13+1.3 M $\Omega$	GK 809 31	26	5600 $\Omega$	GK 776 10/5K6

C o i l s   a n d   T r a n s f o r m e r s

S 1	700 W	44 Ω	Humfilter GK 567 79	S20	260 W	7.4 Ω	IF transf.I
				21	175 W	4.5 Ω	GK 567 95
2	30 W	<1 Ω	aer.coil SW I	22	260 W	7.4 Ω	IF transf.II
3	9 W	<1 Ω	GK 569 15	23	175 W	4.5 Ω	GK 567 95
4	31 W	1.8 Ω	aer.coil SW II	24	2400 W	610 Ω	output transf.
5	20 W	<1 Ω	GK 569 16	25	88 W	<1 Ω	GK 514 32
6	161 W	11 Ω	aer.coil SW III	26	160 W	39 Ω	
7	38 W	<1 Ω	GK 568 10	27	620 W	16 Ω	supply transf.
8	58 W	1.1 Ω	aer.coil MW GK 567 28	28	107 W	2.7 Ω	GK 514 28
				29	143 W	3.3 Ω	
9	196 W	9 Ω	IF filter	30	300 W	11.5 Ω	
10	802 W	55 Ω	A3 126 85	31	120 W	4.5 Ω	
				32	190 W	6.4 Ω	
11	16 W	<1 Ω	osc.coil SW I	33	1620 W	195 Ω	
12	4 W	<1 Ω	GK 568 11	34	1620 W	180 Ω	
13	6 W	<1 Ω		35	41 W	<1 Ω	
				36	41 W	<1 Ω	
14	6 W	<1 Ω	osc.coil SW II	S37 Loudspeaker LS 17 12 11  V1) Dial illumination lamps 8045D V2)			
15	20 W	<1 Ω	GK 568 52				
16	8 W	<1 Ω	osc.coil SW III				
17	27 W	1.7 Ω	GK 568 14				
18	21 W	1.5 Ω	osc.coil MW				
19	90 W	5.5 Ω	GK 568 15				



FIG. 1

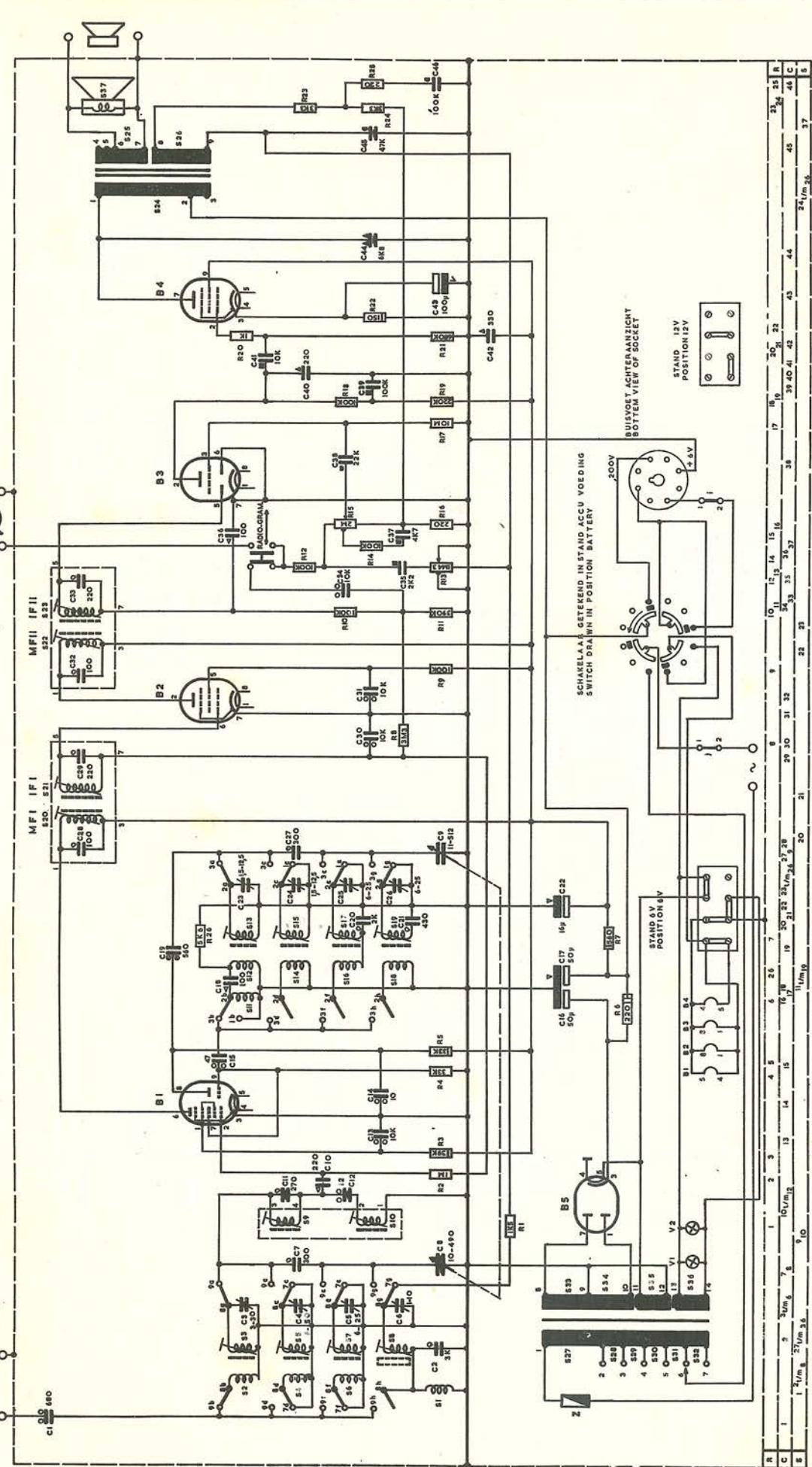

**Condensadores**  
**Condensatoren. Condensers.**

STYROFOL  
 100V 500V  
 100V 500V

KERAMISCH  
 CERAMIC  
 350V 500V 500V

PAPIER  
 PAPER  
 100V 100V 100V

ELECTROLYTISCH  
 ELECTROLYTIC  
 100V 100V 100V

Resistencia  
 Weerstanden  
 Resistors  
 0.5W 1W 1.5W

**Aansluitingen MF filter**  
**Genericus filtere F.I.**

**Aansluitingen MF transformatoren**  
**IF transformer connections**

**Aansluitingen op golfbereikschakelaar**  
**Wave range switch connections**

**Buisvoet aansluitingen**  
**Tubesocket connections**

**Stand 6V POSITION 0V**

**Stand 12V POSITION 12V**

**SCHAKELAAR GETEKEND IN STAND ACCU VOEDING**  
**SWITCH DRAWN IN POSITION BATTERY**

**BUISSVOET ACHTERAANZICHT**  
**BOTTOM VIEW OF SOCKET**

**Plaats de mentaje del transformador**

**4bandas de onda OM.-OC.III-OC.II-OC.I**  
**Dibujado en la posición O.C.I**

**Golf bereiken: M.G.: KG.III.; KG.II.en KG.I.**  
**Getekend in stand KG.I.**  
**Waveranges: MW.: SW.III.; SW.II. and SW.I.**  
**Shown in position SW.I**

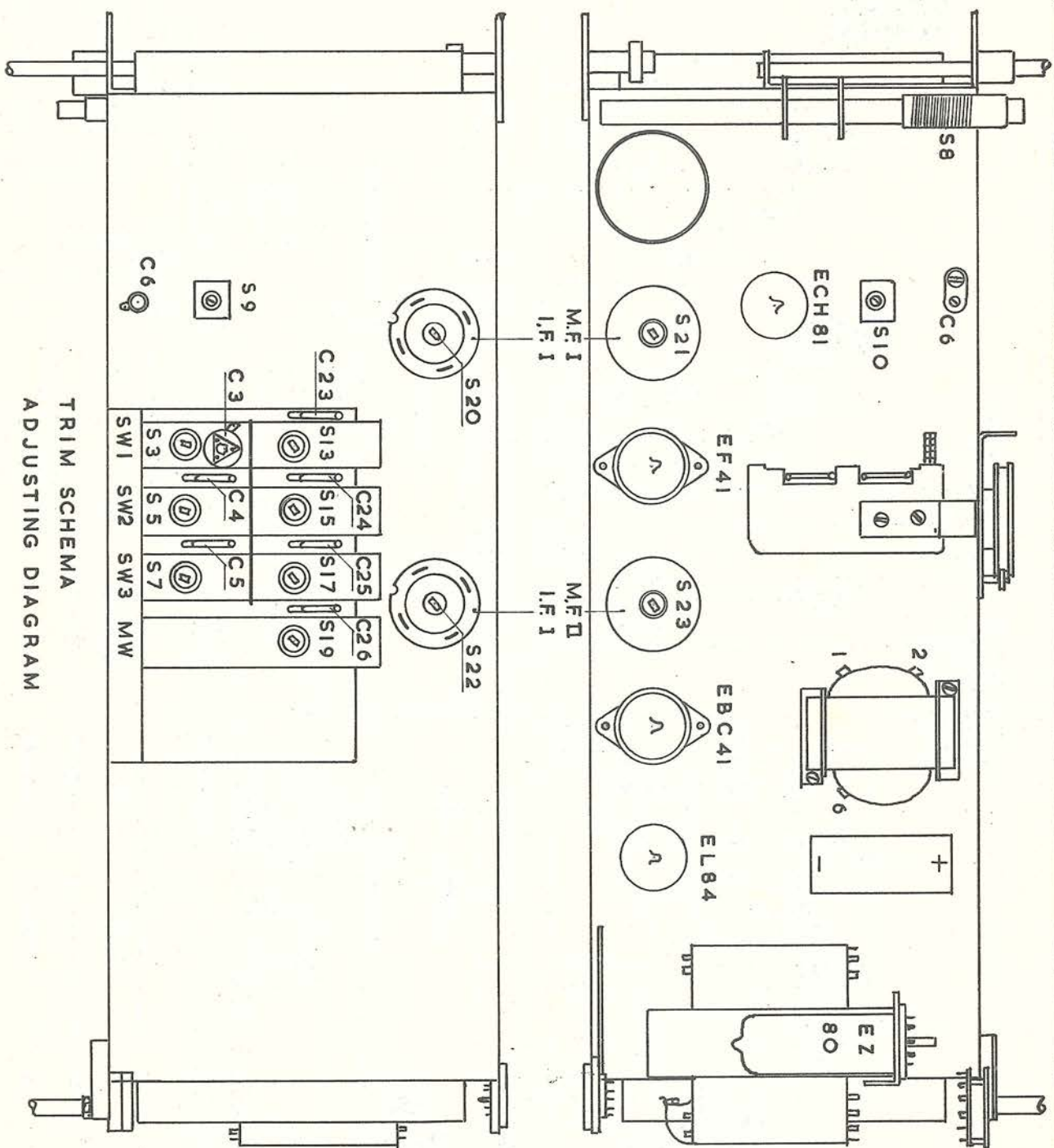
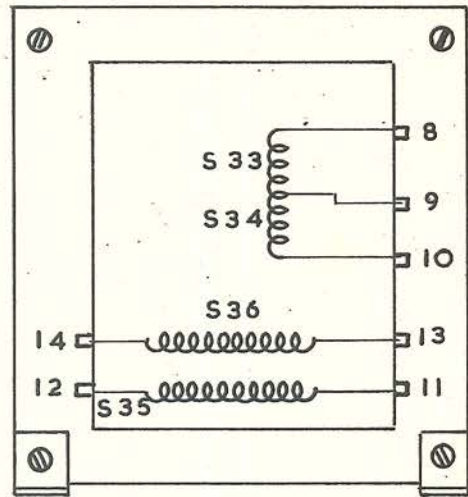
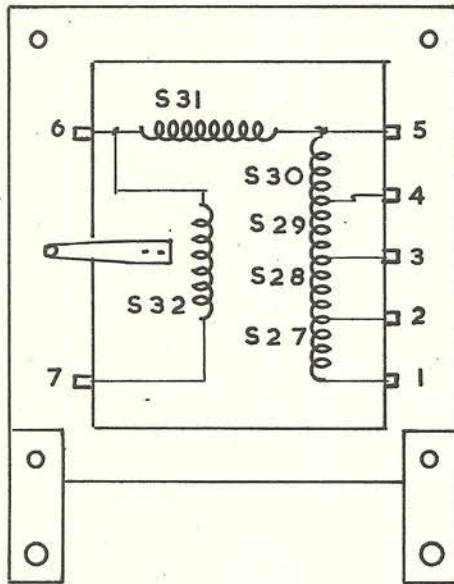

FIG. 2

TRIM SCHEMA  
ADJUSTING DIAGRAM



FIG. 3



VOEDINGS TRANSFORMATOR ]  
SUPPLY TRANSFORMER ] GK 514 28

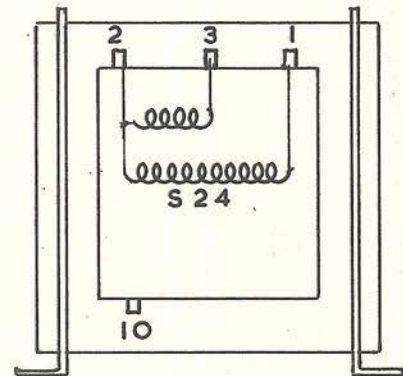
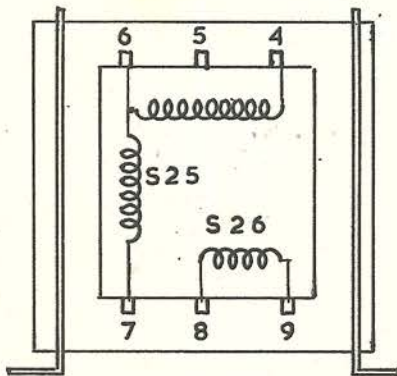

UITGANGS TRANSFORMATOR ]  
OUTPUT TRANSFORMER ] GK 514 32

auteursrecht volgens de wet wet voorbehouden / protected by law.

FIG. 4

CONDENSATOR GEHEEL IN GEDRAAID  
VARIABLE COND. IN POSITION OF MAXIMUM  
CAPACITY

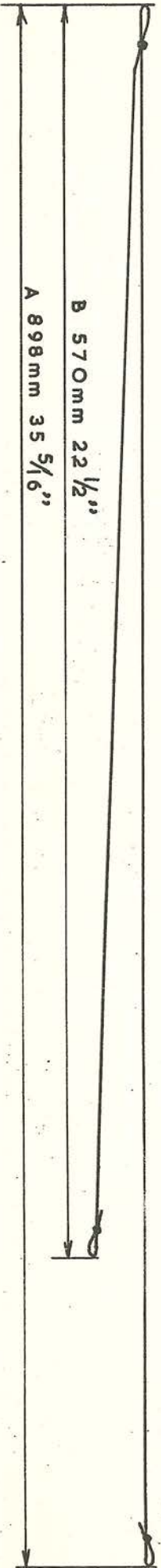
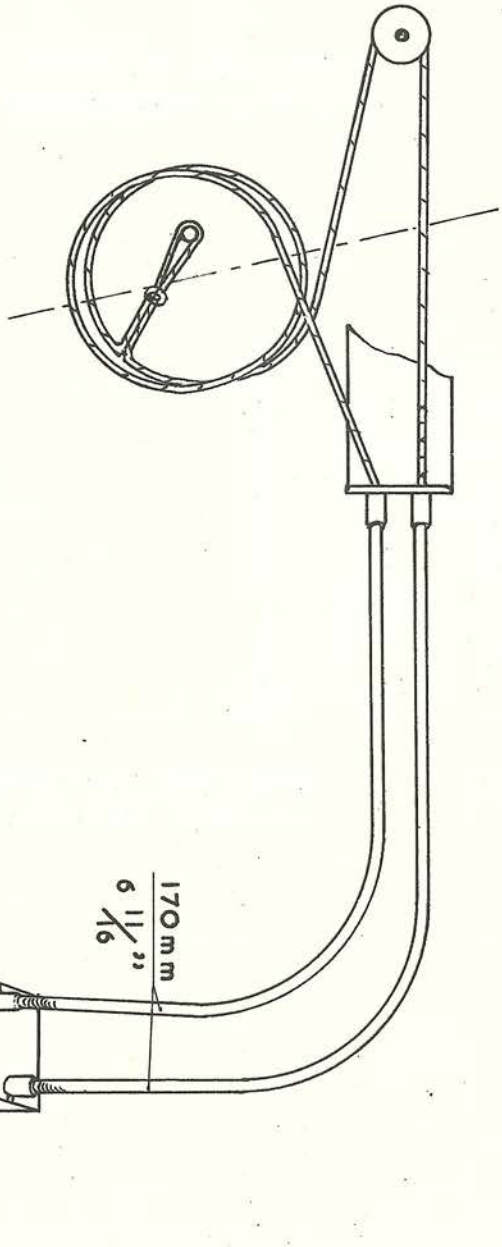

B 570mm 22 1/2"  
A 898mm 35 5/16"

170mm  
6 11/16"