

SERVICE-DOCUMENTATIE

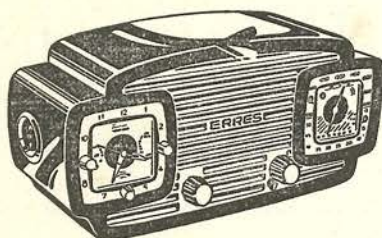

KY 550 } *Ontvangtoestel voor*
KY 5501 } *wissel en gelijkstroom*

KY 5501 *Tropenbestendig*



I. A L G E M E N E G E G E V E N S

- a. Golfbereiken:
- | | | |
|---------|---------------|--------------|
| KY 550 | Korte golf | 13,4 - 52 m |
| | Midden golf | 185 - 585 m |
| | Lange golf | 950 - 1950 m |
| KY 5501 | Korte golf I | 13,4 - 42 m |
| | Korte golf II | 40 - 140 m |
| | Midden golf | 185 - 585 m |
- b. Buizen:
- | | |
|-----|--------|
| B 1 | UCH 81 |
| B 2 | UF 41 |
| B 3 | UBC 41 |
| B 4 | UL 41 |
| B 5 | UY 41 |
- c. Kringen:
- Afgestemde HF kringen: 1 + 1
Afgestemde MF kringen: 2 + 2
- d. Middenfrequentie: Nominaal 453 kHz
- e. Gevoeligheid: Beter dan 10 μ V
- f. Uitgangsvermogen: 1,8 W bij 10% vervorming gemeten bij 400 Hz
- g. Selectiviteit: De M.F. bandbreedte voor 10 voudig signaal bedraagt 11 kHz.
- h. Netspanningen: Omschakelbaar voor netspanningen van 127 V en 220 V.
- i. Bedieningsorganen: Volumeregelaar + netschakelaar
Golfbereikschakelaar
Afstemming
- j. Afmeting kast: 374 x 192 x 131 mm
- k. Gewicht: Bruto 6 kg; Netto 3,5 kg.

II. SPANNINGEN EN STROMEN

	B 1 UCH 81	B 2 UF 41	B 3 UBC 41	B 4 UL 41	
Va	172	172	56	190	Volt
Vg scherm	102	102		172	Volt
Vg	-1,8	-1,3	-1,7		Volt
Va triode	105				Volt
Ia	3	7,5		44,5	mA
Ig scherm	3,7	5,3		8	mA

$V_{C28}=200$ Volt; $V_{C29}=170$ Volt.

III. TRIMVOORSCHRIFT

Meetzender: 30% moduleren met 400 Hz.

Wijzerinstelling: Var. condensator geheel uitdraaien, wijzer instellen op begin van de schaal. Draaiingshoek var. condensator $172,5^{\circ}$.

Trimpunten: Op afstemschaal zijn merktekens aangegeven voor $8,3^{\circ}$ 35° 152° en 160° .

Afregeling: Volumeregelaar op maximum.

NB.: De volgorde van afregelen is: LG-MG-KG KY 550

Bereik	Meetfrequentie	Condensatorstand	Aansluiting	Afregeling	
MF	450 Kc	180° MG	via cond. van 22000 pF op g1 UCH 81	resp. S27/S26 S25/S24	
MF antenne filter	450 Kc	180° MG	via 22000 pF op top MG spoel	Beide kernen uitgedraaid. S22/S23	
				Osc. kring	Ant. kring
KG KY 550	6,5 Mc 22 Mc	152° $8,3^{\circ}$	via kunst-antenne	S19 C24	S15 C7
MG KY 550	570 Kc 1600 Kc	152° $8,3^{\circ}$	idem	S13 C26	S6 C9
LG KY 550	166 Kc 300 Kc	152° 35°	idem	S21 C27	S16 C11
KG I KY 5501	7,5 Mc 22 Mc	152° $8,3^{\circ}$	idem	S9 C24	S3 C6
KG II KY 5501	2,3 Mc 7,5 Mc	160° $8,3^{\circ}$	idem	S11 C25	S5 C8
MG KY 5501	570 Kc 1600 Kc	152° $8,3^{\circ}$	idem	S13 C26	S6 C10

C o n d e n s a t o r e n

C 1	1000 pF	E 202 02/1K	C24	6-25 pF	82754/25E
2	22000 pF	E 202 10/22K	25	6-25 pF	82754/25E
3	470 pF	E 360 05/470E	26	10-50 pF	82754/50E
4	4000 pF	E 222 10/4K	27	10-50 pF	82754/50E
5	3000 pF	E 360 05/3K	28	50 μ F)	GK 180 32
6	3-30 pF	7864/01	29	50 μ F)	
7	1-6 pF	82754/6E	30	10000 pF	E 105 50/10K
8	1-6 pF	82754/6E	31	22000 pF	E 105 50/22K
9	1-6 pF	82754/6E	32	100 pF	E 360 02/100E
10	6-25 pF	82754/25E	33	220 pF	E 360 02/22CE
11	10-50 pF	82754/50E	34	0,1 μ F	E 201 10/100K
12	27 pF	E 103 10/27E	35	100 pF	E 360 02/100E
13	10000 pF	E 105 50/10K	36	220 pF	E 360 02/220E
14	10-489 pF)	GK 210 56-1	37	100 pF	E 103 10/100E
15	12-507 pF)		38	10000 pF	GK 198 42
16	270 pF	E 360 05/270E	39	6800 pF	E 105 50/6K8
17	12 pF	E 101 05/12E	40	3000 pF	E 210 10/3K
18	47 pF	E 103 10/47E	41	220 pF	E 103 10/220E
19	470 pF	E 103 10/470E	42	0,1 μ F	E 201 10/100K
20	120 pF	E 103 05/120E	43	10000 pF	GK 198 42
21	1600 pF	E 360 05/1K6	44	22000 pF	E 202 10/22K
22	445 pF	E 360 01/445E	45	120 pF	E 103 10/120E
23	195 pF	E 360 02/195E			

W e e r s t a n d e n

R 1	1000 Ω	GK 790 33	R13	2,2 M Ω	GK 776 10/2M2
2	180 Ω	GK 790 08	14	0,27 M Ω	GK 776 10/270K
3	2700 Ω)	GK 790 39	15	33000 Ω	GK 776 10/33K
4	300 Ω)	(300+2700)	16	2 M Ω	GK 809 39 potm.log,
5	150 Ω	GK 776 10/150E	17	0,1 M Ω	GK 776 10/100K
6	1 M Ω	GK 776 10/1M	18	10 M Ω	GK 776 10/10M
7	33000 Ω	GK 776 10/33K	19	0,1 M Ω	GK 776 10/100K
8	15000 Ω	GK 777 10/15K	20	0,22 M Ω	GK 776 10/220K
9			21	0,82 M Ω	GK 776 10/820K
10	1200 Ω	GK 778 10/1K2	22	1000 Ω	GK 776 10/1K
11	1000 Ω	GK 776 10/1K	23	180 Ω	GK 777 10/180E
12	8200 Ω	GK 777 10/8K2			

S p o e l e n e n T r a f o ' s

S 1	93 W	2 Ω	antibromfilter GK 567 30	S20	34 W	4,5 Ω	osc.spoel
2	26 W	<1 Ω	ant.spoel	21	180 W	13,5 Ω	720-2000m GK 568 21
3	9 W	<1 Ω	13,5-42 m GK 567 71	22	196 W		M.F.filter
4	115 W	12 Ω	ant.spoel	23	802 W		A3 126 85
5	42 W	<1 Ω	40-140m GK 568 59	24	175 W	4,5 Ω	MF I trafo
6	61 W	1,3 Ω	ant.spoel	25	260 W	7,4 Ω	GK 567 95
7	27 W	<1 Ω	175-580m GK 567 62	26	175 W	4,5 Ω	MF II trafo
8	5 W	<1 Ω	osc.spoel	27	260 W	7,4 Ω	GK 567 95
9	9 W	<1 Ω	13,5-42m GK 568 53	28	2100 W	375 Ω	uitgangs-
10	7½ W	<1 Ω	osc.spoel	29	65 W	1,7 Ω	transforma-
11	25½ W	<1 Ω	40-140m GK 567 78	30	12 W		tor GK 513 99
12	21 W	1,7 Ω	osc.spoel	31	Luidspreker		LS 13 09 06
13	80 W	4,8 Ω	175-580m GK 568 20	L 1	8003D schaalverlichtingslampje		12V/100mA
14	27 W	4,5 Ω	ant.spoel	G 1	GK 977 69	} schakelaarsegmenten	
15	12 W	1 Ω	13,5-52m GK 567 72	G 2	GK 977 43		
16	200 W	15 Ω	ant.spoel	G 3	GK 977 42		
17	42 W	<1 Ω	720-2000m GK 567 63-1				
18	5 W	<1 Ω	osc.spoel				
19	11 W	<1 Ω	13,5-52m GK 568 70				

FIG. 1

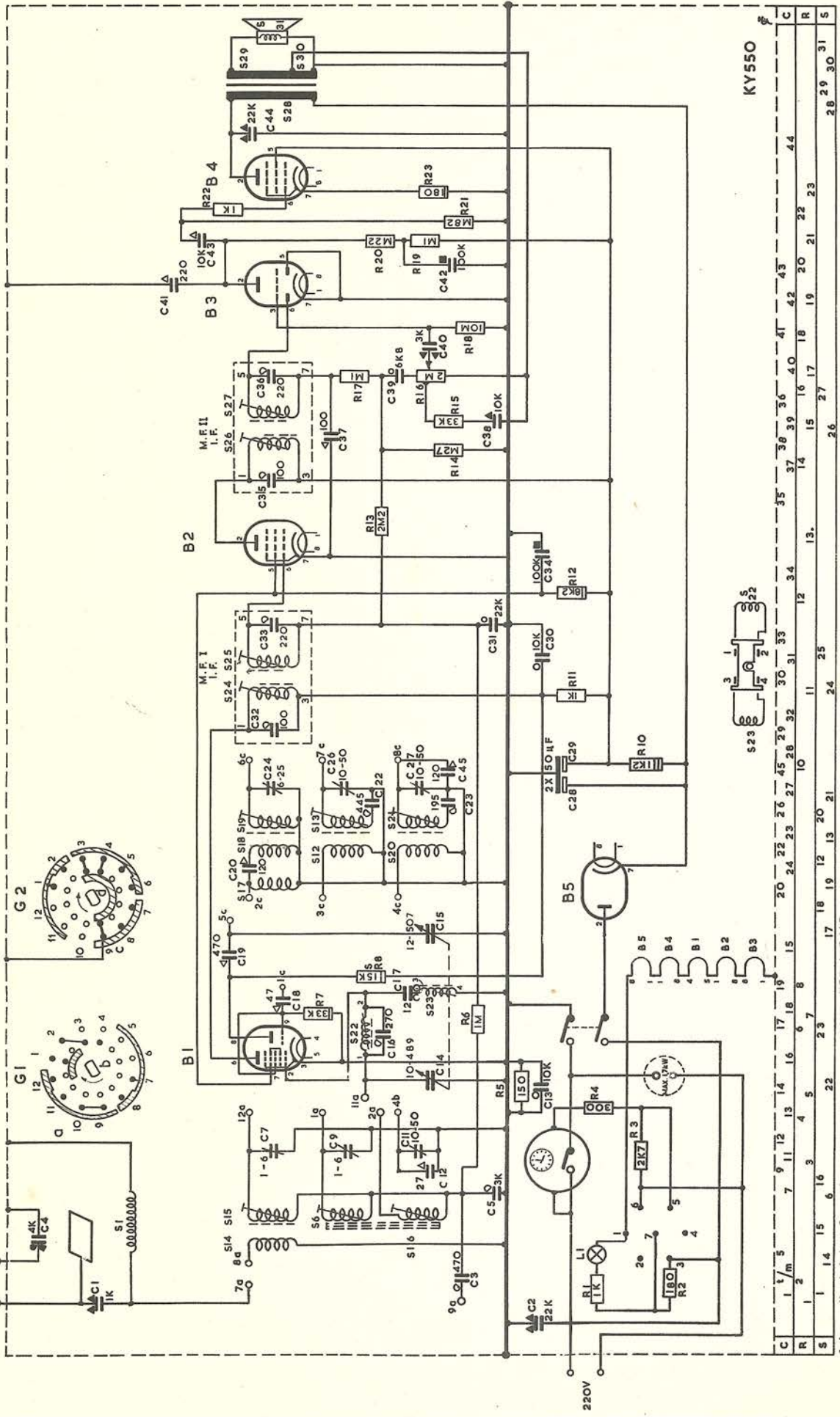

KY550

C	1	2	3	4	5	6	7	8	9	10	11	12	13	14	15	16	17	18	19	20	21	22	23	24	25	26	27	28	29	30	31	S
R	1	2	3	4	5	6	7	8	9	10	11	12	13	14	15	16	17	18	19	20	21	22	23	24	25	26	27	28	29	30	31	S

CONDENSATOREN
 Paper Paper
 Styroflex 125V
 350V 400V 600V
 500V
 Ceramic Keramischs
 250V 350V 500V
 Trimmer

WEERSTANDEN
 RESISTORS
 0.5W 1W 2W

BI UCH 81

B2 UF 41
B3 UBC41

B4 UL 41
B5 UY 41

AANSLUITPLAAT M.F.
 Gelfberischaakelaar 3 standen KG-MG-LG.
 Getekend in stand KG
 Wavrange switch 3 positions SW-MW-LW
 Draaien in position SW

125V 1-7
 220V 2-7
 2-4-5
 3-5-6

FIG. 1

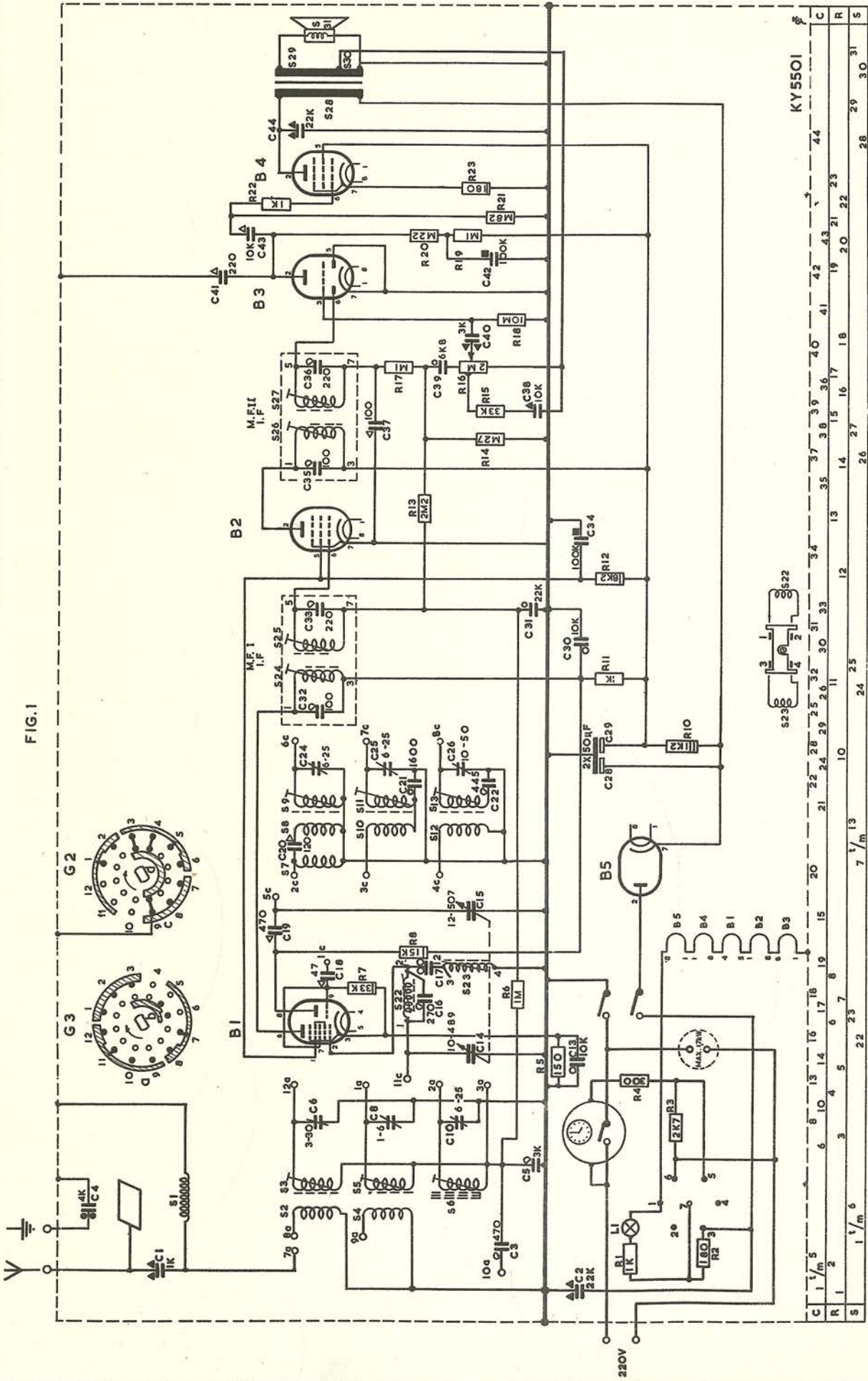
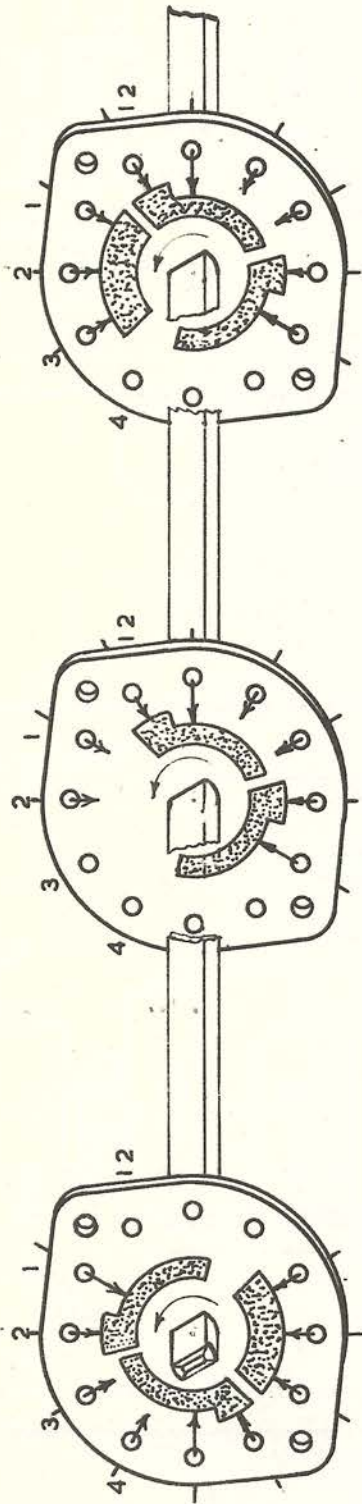

FIG. 2



G 2

G 1

G 3

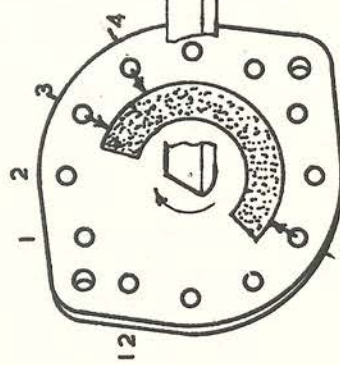

GK 977 43
(KY 550)
(KY 5501)

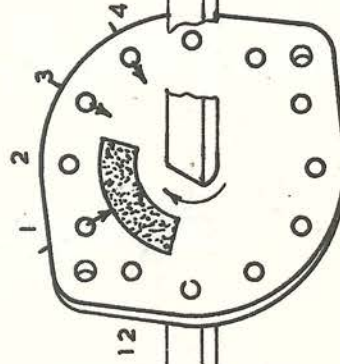

GK 977 69
(KY 550)

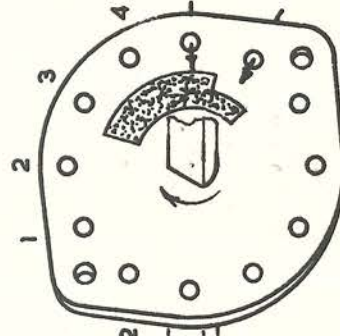

GK 977 42
(KY 5501)

KY 5501

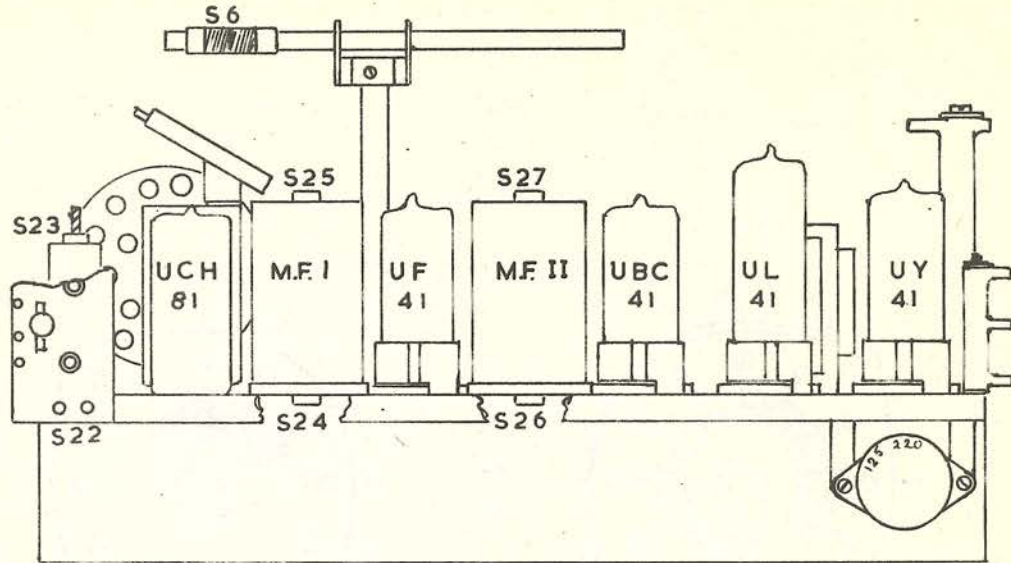
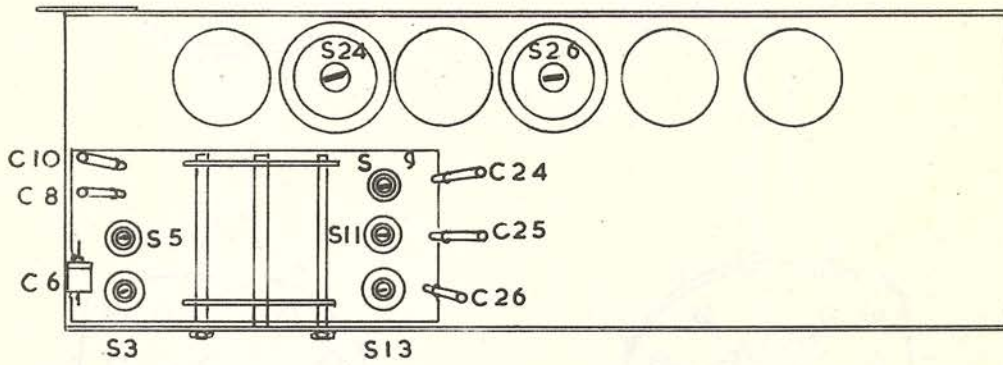

FIG.3a



TRIM SCHEMA
ADJUST DIAGRAM

KY 550

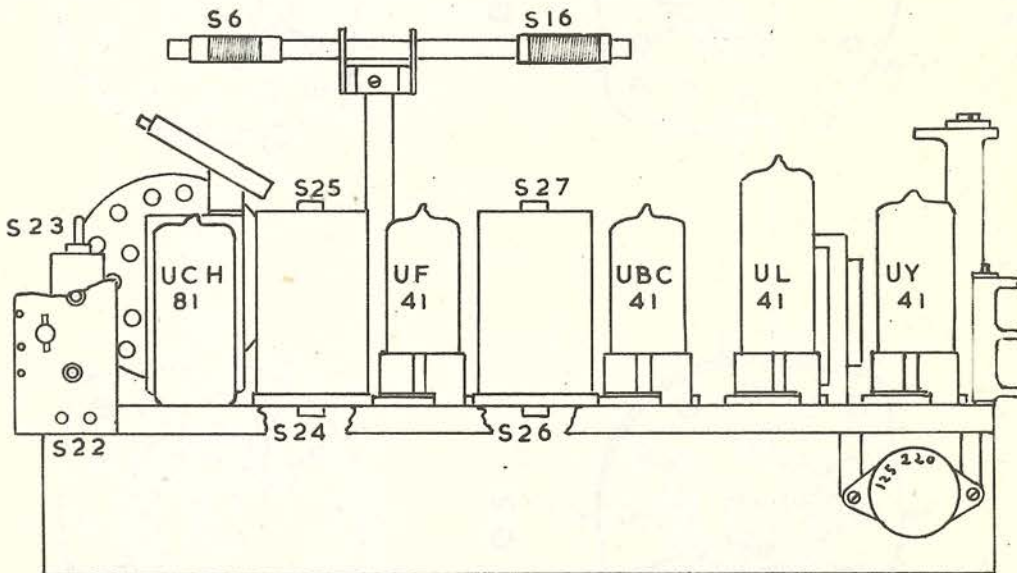
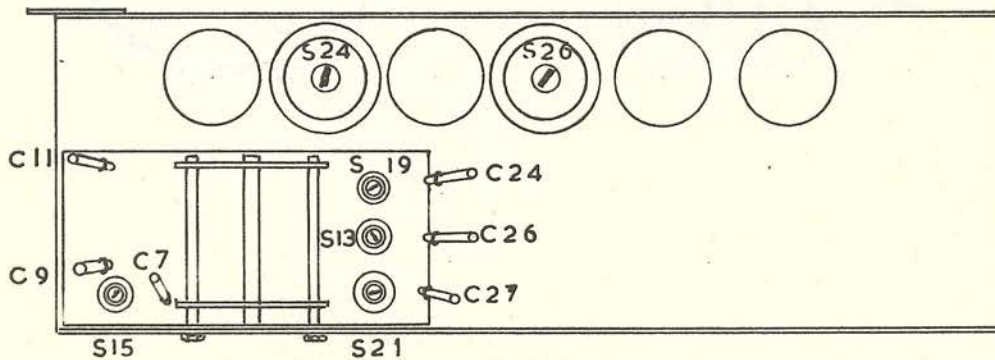

FIG.3



Auteursrecht volgens de wet voorbehouden

VARIABLE CONDENSER IN POSITION OF MAXIMUM CAPACITY
2-VOUD CONDENSATOR GEHEEL INGEDRAAID

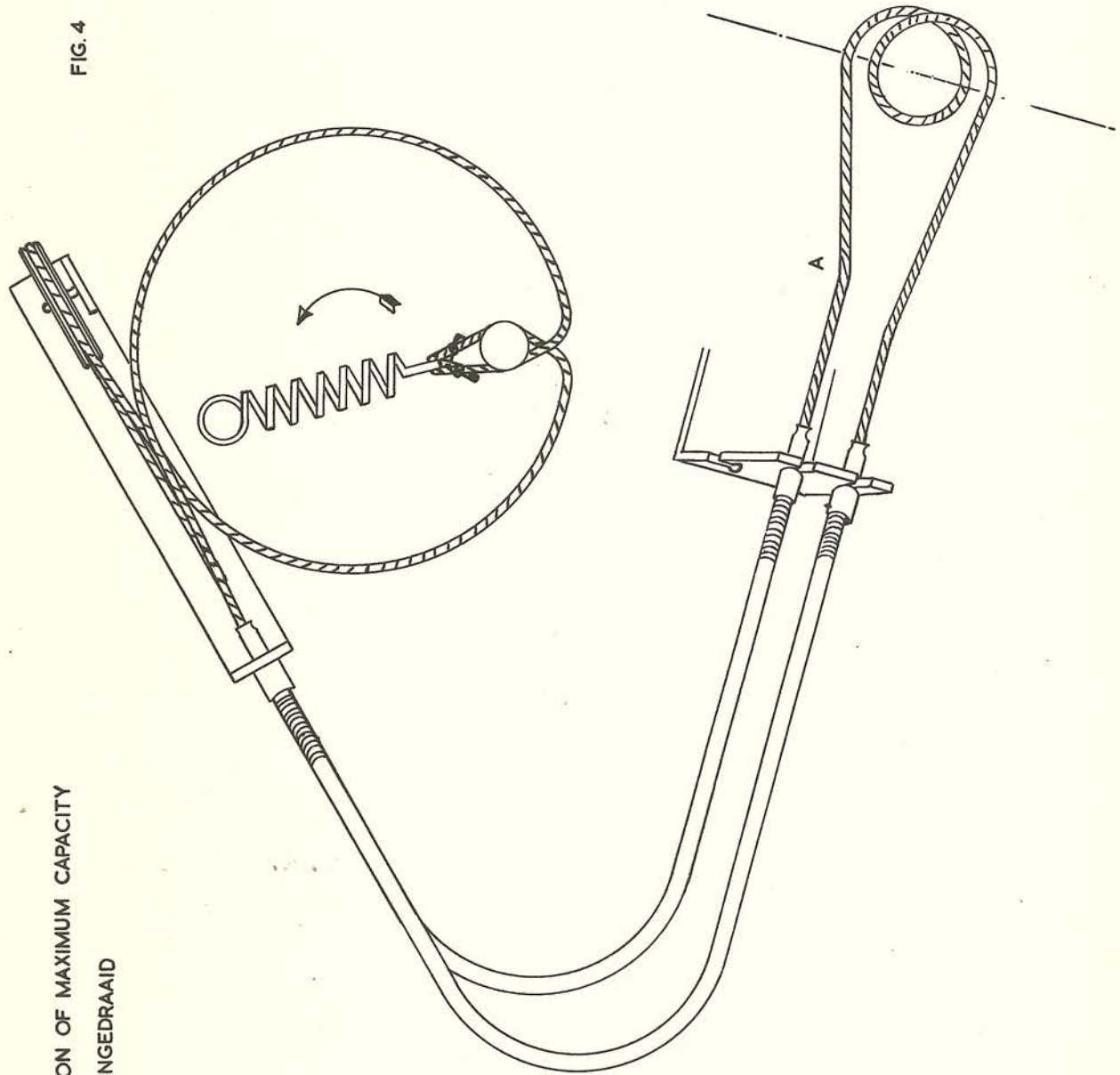

FIG. 4

KY 550
KY 550 I

LENGTH OF CORD
A = 2 4/8"

SNAARLENGTE
A = 613 MM