

AK.383
SERVICE DOCUM:

Auteursrecht volgens de wettelijke bepalingen

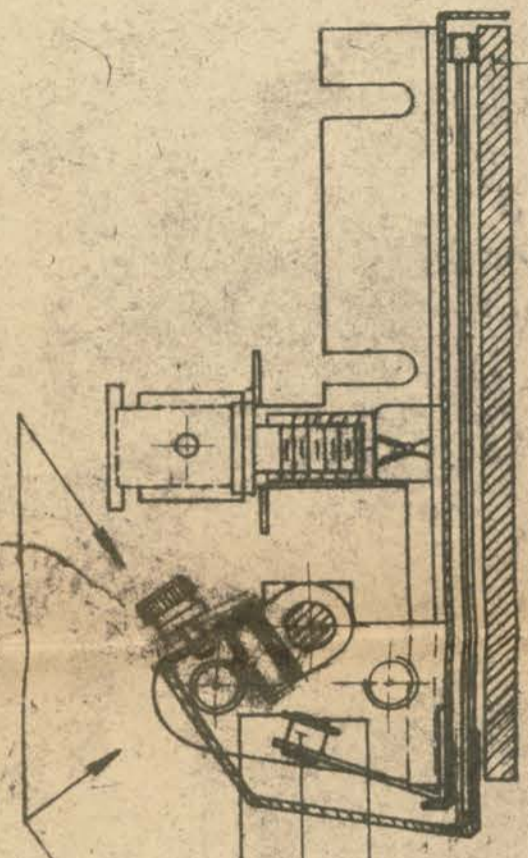

18
19
20
28

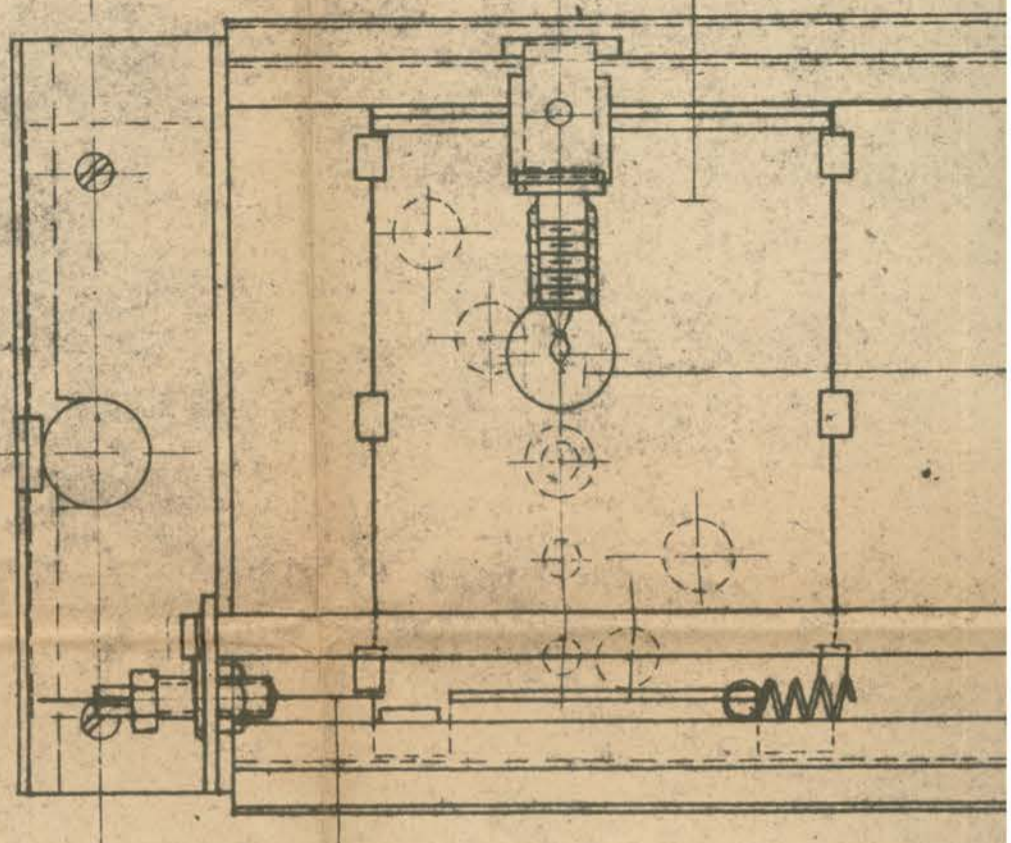

3
23 VILT VASTMAKEN MET RUBBERKIT

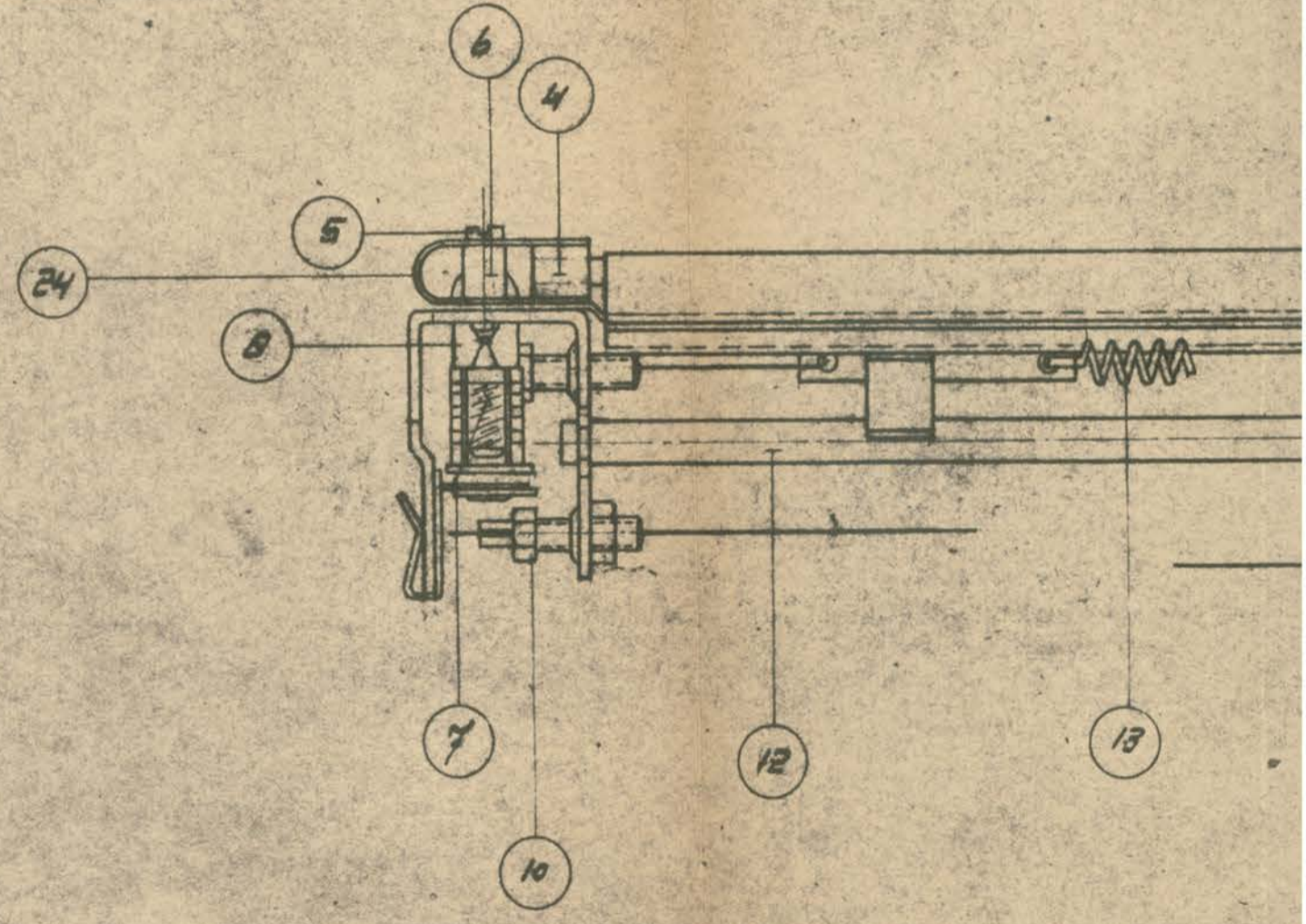

4
5
6
7
8
10
12
13
24

3 9 25 1

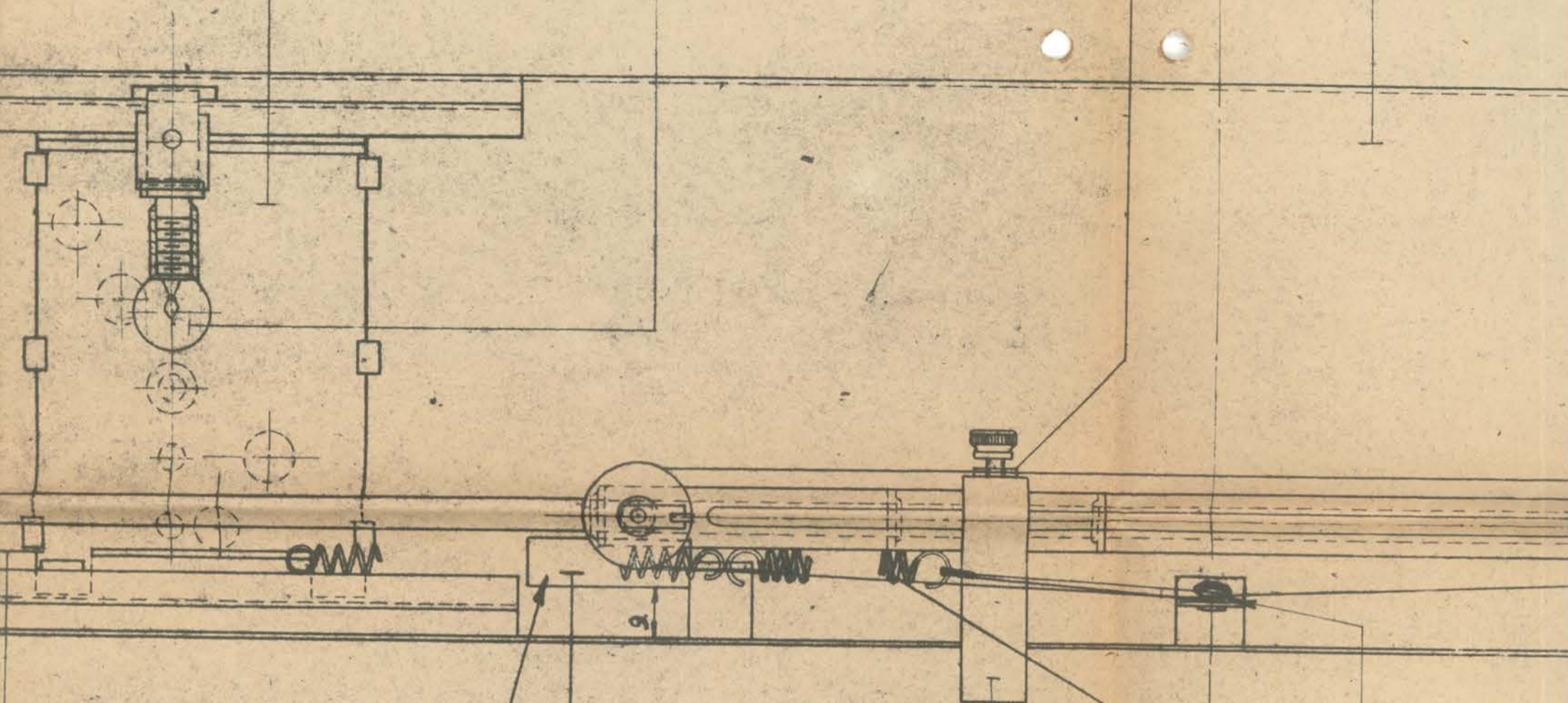

VILT VASTMAKEN MET RUBBERKIT

SLEDE EN WYZERHOUDER GETEKEND VOLGENS PYLAANZICHTEN

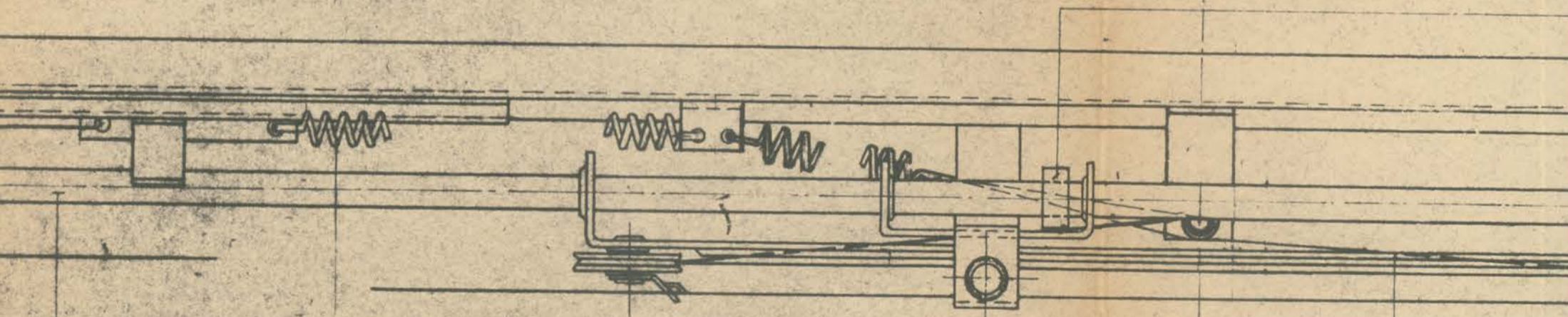

12 13 14

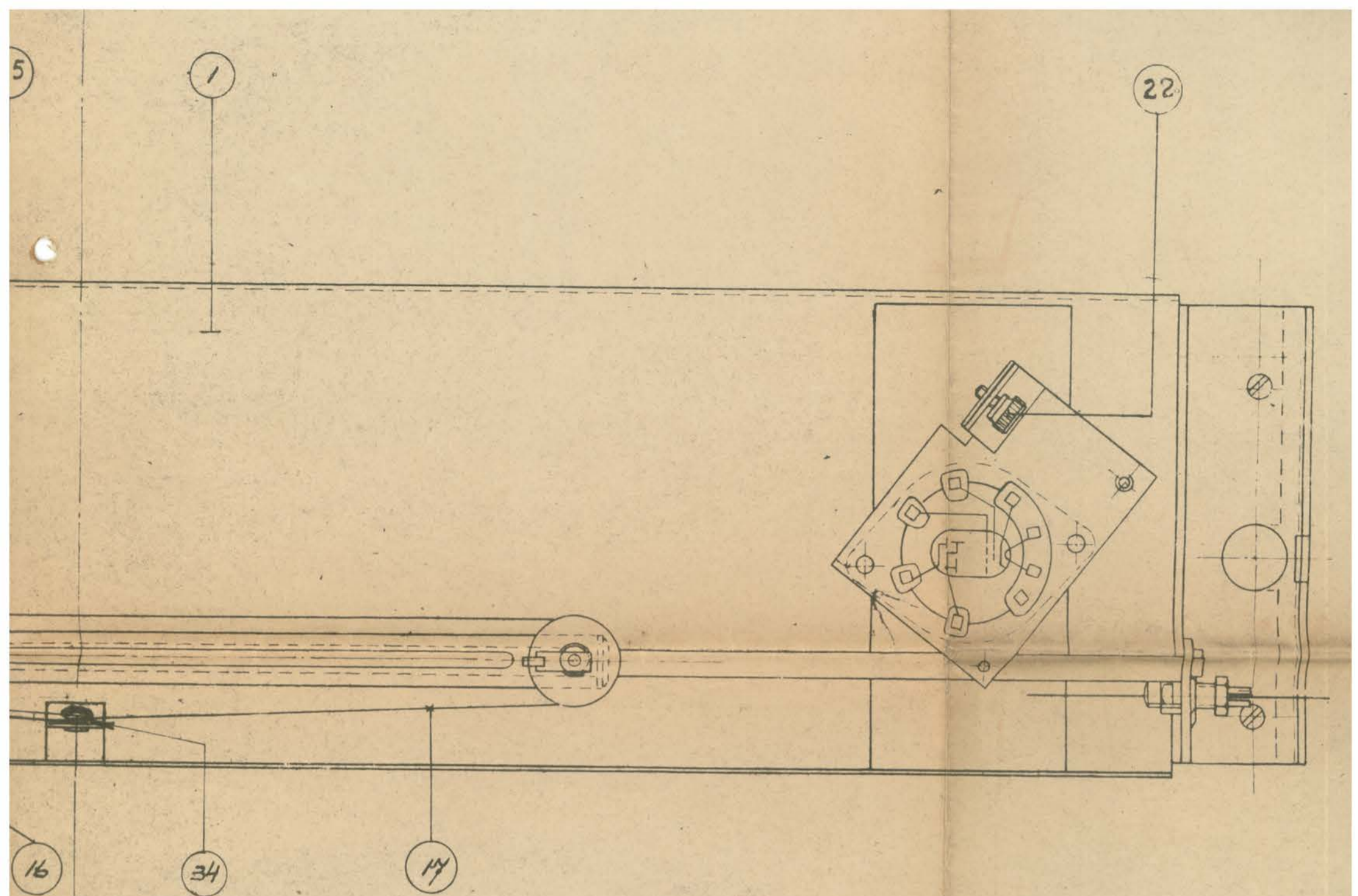

VOLGENS PYLAANZICHTEN

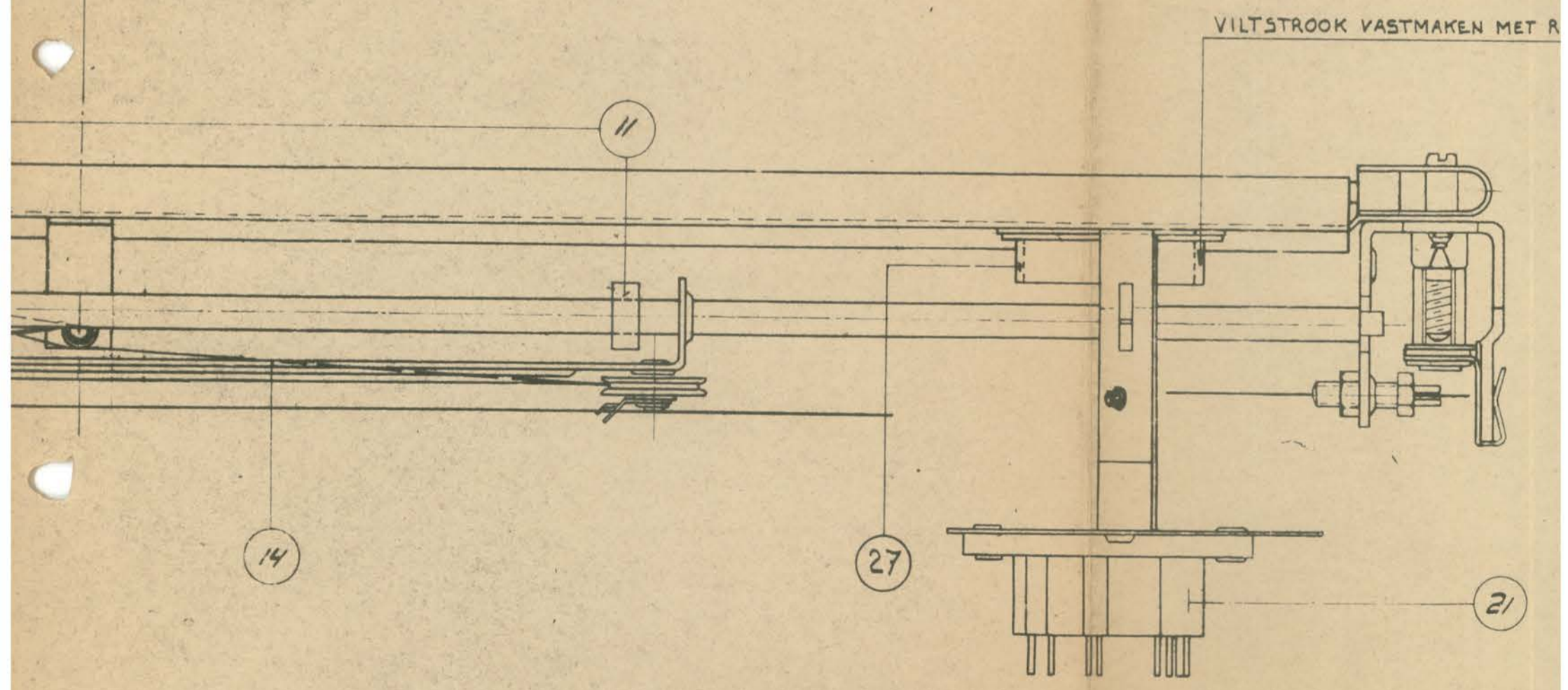

VILTSTROOK VASTMAKEN MET R

HOEV. HEID	OMSCHRIJVING MATERIAAL
MATERIAAL:	
OMSCHRIJVING	AK.383.
	SATT. SCHAALTECHANISME.

22

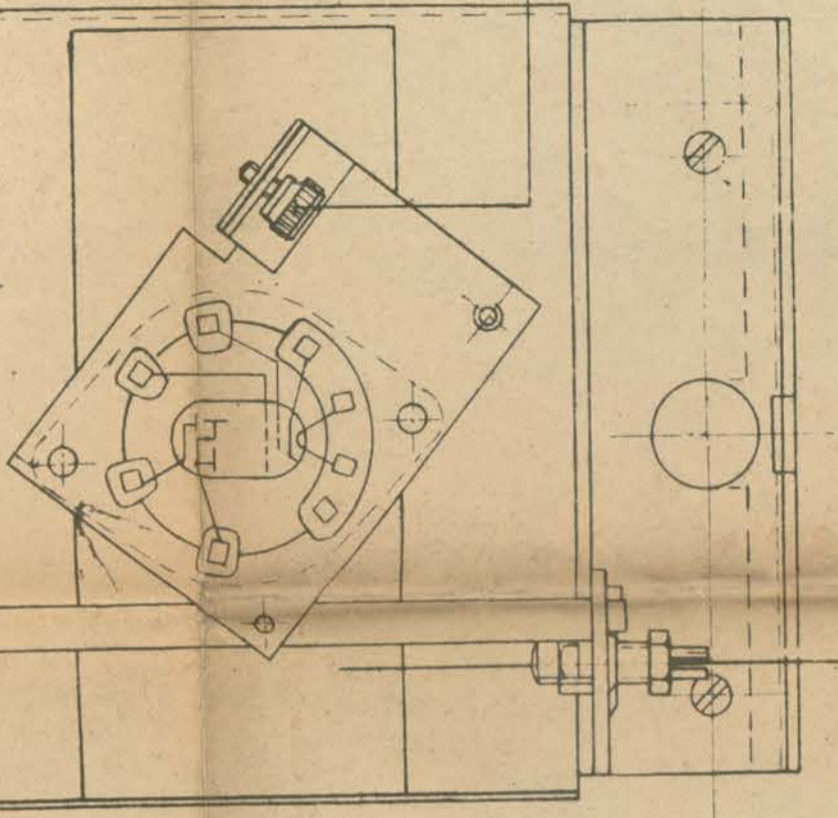

VILTSTROOK VASTMAKEN MET RUBBERKIT.

2

27

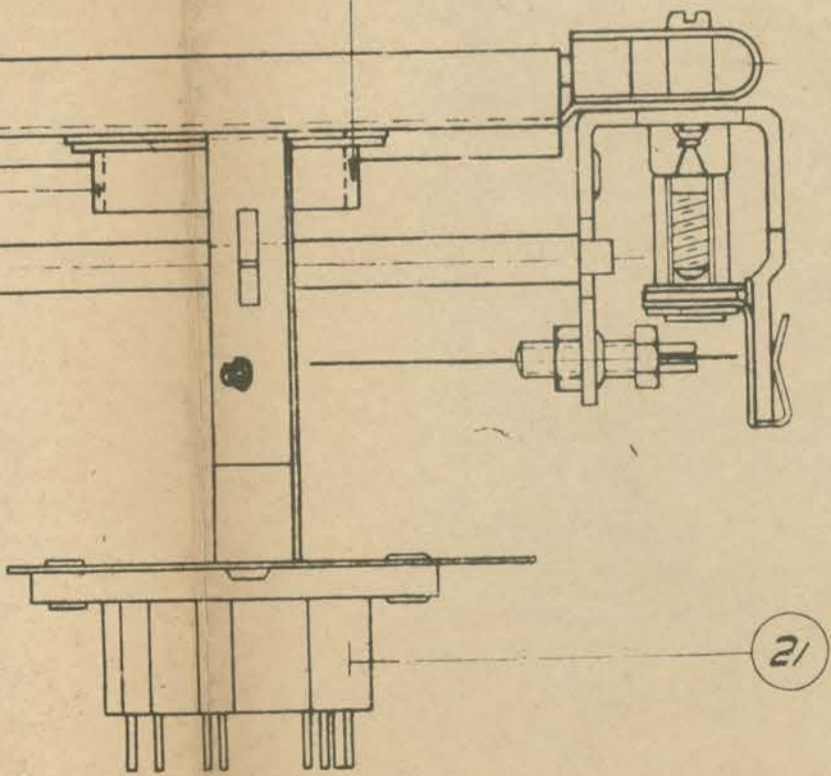

2/

GEW. 23.6.37.

HOEV. HEID	OMSCHRIJVING MATERIAAL	AFM	NORM-AANDUIDING	CODENUMMER	OPMERKINGEN	Post Nr.
MATERIAAL:			UITVOERING:			
	OMSCHRIJVING <i>AK.383.</i>		Laatste vlijt.	V = VOORBEWERKT	25 ± 0,5	A 1
				VV = NABEWERKT	25,0 ± 0,2	
			dat.:	VVV = GLADBEWERKT	25,0 ± 0,08	